



Programmable Controller



FX3GC Series Programmable Controller

HARDWARE MANUAL



Manual Number	JY997D45201
Revision	D
Date	November 2016

This manual describes the part names, dimensions, mounting, cabling and specifications for the product. This manual is extracted from FX3GC Series User's Manual - Hardware Edition. Refer to FX3GC Series User's Manual - Hardware Edition for more details. Before use, read this manual and manuals of relevant products fully to acquire proficiency in the handling and operating the product. Make sure to learn all the product information, safety information, and precautions.

And, store this manual in a safe place so that you can take it out and read it whenever necessary. Always forward it to the end user.

Registration

The company name and the product name to be described in this manual are the registered trademarks or trademarks of each company.

Effective November 2016

Specifications are subject to change without notice.

© 2012 Mitsubishi Electric Corporation

Safety Precaution (Read these precautions before use.)

This manual classifies the safety precautions into two categories:

WARNING and **CAUTION**.

WARNING	Indicates that incorrect handling may cause hazardous conditions, resulting in death or severe injury.
CAUTION	Indicates that incorrect handling may cause hazardous conditions, resulting in medium or slight personal injury or physical damage.

Depending on the circumstances, procedures indicated by **CAUTION** may also cause severe injury.

It is important to follow all precautions for personal safety.

STARTUP AND MAINTENANCE PRECAUTIONS	WARNING
<ul style="list-style-type: none"> Do not touch any terminal while the PLC's power is on. Doing so may cause electric shock or malfunctions. Before cleaning or retightening terminals, cut off all phases of the power supply externally. Failure to do so may cause electric shock. 	

STARTUP AND MAINTENANCE PRECAUTIONS	WARNING
<ul style="list-style-type: none"> Use the battery for memory backup correctly in conformance to FX3GC Series User's Manual - Hardware Edition. <ul style="list-style-type: none"> Use the battery only for the specified purpose. Connect the battery correctly. Do not charge, disassemble, heat, put in fire, short-circuit, connect reversely, weld, swallow or burn the battery, or apply excessive forces (vibration, impact, drop, etc.) to the battery. Do not store or use the battery at high temperatures or expose to direct sunlight. Do not expose to water, bring near fire or touch liquid leakage or other contents directly. Incorrect handling of the battery may cause heat excessive generation, bursting, ignition, liquid leakage or deformation, and lead to injury, fire or failures and malfunctions of facilities and other equipment. Before modifying or disrupting the program in operation or running the PLC, carefully read through this manual and the associated manuals and ensure the safety of the operation. An operation error may damage the machinery or cause accidents. 	

STARTUP AND MAINTENANCE PRECAUTIONS	CAUTION
<ul style="list-style-type: none"> Do not disassemble or modify the PLC. Doing so may cause fire, equipment failures, or malfunctions. For repair, contact your local Mitsubishi Electric representative. Turn off the power to the PLC before connecting or disconnecting any extension cable. Failure to do so may cause equipment failures or malfunctions. Turn off the power to the PLC before attaching or detaching the following devices. Failure to do so may cause equipment failures or malfunctions. <ul style="list-style-type: none"> Peripheral devices, extension units/blocks, special adapters, FX Series terminal blocks, extension power supply unit, connector conversion adapter and battery. 	

DISPOSAL PRECAUTIONS	CAUTION
<ul style="list-style-type: none"> Please contact a certified electronic waste disposal company for the environmentally safe recycling and disposal of your device. When disposing of batteries, separate them from other waste according to local regulations. (For details of the Battery Directive in EU countries, refer to FX3GC Series User's Manual - Hardware Edition.) 	

TRANSPORTATION AND STORAGE PRECAUTIONS	CAUTION
<ul style="list-style-type: none"> When transporting the FX3GC Series PLC incorporating the optional battery, turn on the PLC before shipment, confirm that the battery mode is set using a parameter and the ALM LED is OFF, and check the battery life. If the PLC is transported with the ALM LED on or the battery exhausted, the battery-backed data may be unstable during transportation. The PLC is a precision instrument. During transportation, avoid impacts larger than those specified in Section 2.1 by using dedicated packaging boxes and shock-absorbing palletes. Failure to do so may cause failures in the PLC. After transportation, verify operation of the PLC and check for damage of the mounting part, etc. When transporting lithium batteries, follow required transportation regulations. (For details of the regulated products, refer to FX3GC Series User's Manual - Hardware Edition.) 	

Certification of UL, cUL standards

Please consult with Mitsubishi Electric for information on UL, cUL standard practices and the corresponding types of equipment.

Compliance with EC directive(CE Marking)

This document does not guarantee that a mechanical system including this product will comply with the following standards. Compliance to EMC directive and LVD directive of the entire mechanical system should be checked by the user / manufacturer. For more details please contact the local Mitsubishi Electric sales site.

Requirement for Compliance with EMC directive

The following products have shown compliance through direct testing (of the identified standards below) and design analysis (through the creation of a technical construction file) to the European Directive for Electromagnetic Compatibility (2014/30/EU) when used as directed by the appropriate documentation.

Attention
This product is designed for use in industrial applications.

Type : Programmable Controller (Open Type Equipment)
Models : MELSEC FX3GC series, FX3U(C) series and FX2NC series manufactured

from June 1st, 2005	FX3U-232ADP FX3U-4AD-ADP FX3U-4AD-PT-ADP	FX3U-485ADP FX3U-4DA-ADP FX3U-4AD-TC-ADP
from April 1st, 2007	FX3U-232ADP-MB	FX3U-485ADP-MB
from October 1st, 2007	FX3UC-1PS-5V FX2NC-★EX FX2NC-★EX-DS FX2NC-16EX-T	FX2NC-★EYT FX2NC-★EYT-DSS FX2NC-16EX-T-DS
from December 1st, 2007	FX3U-4AD-PTW-ADP FX3U-4AD-PNK-ADP	
from June 1st, 2009	FX3U-3A-ADP	
from January 1st, 2012	FX3GC-32MT/D	FX3GC-32MT/DSS

Standard	Remark
EN61131-2:2007 Programmable controllers - Equipment requirements and tests	Compliance with all relevant aspects of the standard. EMI <ul style="list-style-type: none"> Radiated Emission Conducted Emission EMS <ul style="list-style-type: none"> Radiated electromagnetic field Fast transient burst Electrostatic discharge High-energy surge Voltage drops and interruptions Conducted RF Power frequency magnetic field

Models : MELSEC FX2NC series manufactured
from March 1st, 1999 FX2NC-★EX-DS FX2NC-★EYT-DSS
Where ★★ indicates:16,32
FX2NC-16EX-T-DS FX2NC-16EYR-T-DS
from August 1st, 1999 FX2NC-★EX FX2NC-★EYT
from October 1st, 2007 FX2NC-★EX FX2NC-★EYT
Where ★★ indicates:16,32
FX2NC-16EX-T FX2NC-16EYR-T

Standard	Remark
EN61000-6-4:2007 Generic emission standard Industrial environment EN50081-2:1993 Electromagnetic compatibility	Compliance with all relevant aspects of the standard. <ul style="list-style-type: none"> Emission-Enclosure port Emission-Low voltage AC mains port Emission-Telecommunications/network port
EN61000-6-2:2005 - Generic immunity standard Industrial environment	Compliance with all relevant aspects of the standard. <ul style="list-style-type: none"> Radio-frequency electromagnetic field. Amplitude modulated Fast transients Electrostatic discharge Surges Voltage dips Voltage interruptions Radio-frequency common mode Power-frequency magnetic field

Models : MELSEC FX2N series manufactured

from July 1st, 1997 FX2N-16EX-ES/UL FX2N-16EYR-ES/UL
FX2N-16EYT-ESS/UL
from August 1st, 2005 FX2N-8ER-ES/UL FX2N-8EX-ES/UL
FX2N-8EYR-ES/UL FX2N-8EYT-ESS/UL
from September 1st, 2010 FX2N-8EYR-S-ES/UL

For the products above, PLCs manufactured before March 31st, 2002 are compliant with EN50081-2 (EN61000-6-4) and EN50082-2
from April 1st, 2002 to April 30th, 2006 are compliant with EN50081-2 (EN61000-6-4) and EN61131-2:1994+A11:1996+A12:2000
after May 1st, 2006 are compliant with EN61131-2:2007

Standard	Remark
EN61000-6-4:2007 Generic emission standard Industrial environment EN50081-2:1993 Electromagnetic compatibility	Compliance with all relevant aspects of the standard. <ul style="list-style-type: none"> Emission-Enclosure port Emission-Low voltage AC mains port Emission-Telecommunications/network port
EN50082-2:1995 Electromagnetic compatibility - Generic immunity standard Industrial environment	Compliance with all relevant aspects of the standard. <ul style="list-style-type: none"> RF immunity Fast Transients ESD Conducted Power magnetic fields
EN61131-2:1994 /A11:1996 /A12:2000 Programmable controllers - Equipment requirements and tests	Compliance with all relevant aspects of the standard. <ul style="list-style-type: none"> Radiated electromagnetic field Fast transient burst Electrostatic discharge Damped oscillatory wave
EN61131-2:2007 Programmable controllers - Equipment requirements and tests	Compliance with all relevant aspects of the standard. EMI <ul style="list-style-type: none"> Radiated Emission Conducted Emission EMS <ul style="list-style-type: none"> Radiated electromagnetic field Fast transient burst Electrostatic discharge High-energy surge Voltage drops and interruptions Conducted RF Power frequency magnetic field

Requirement for Compliance with LVD directive

The following products have shown compliance through direct testing (of the identified standards below) and design analysis (through the creation of a technical construction file) to the European Directive for Low Voltage (2014/35/EU) when used as directed by the appropriate documentation.

Models : MELSEC FX2N series manufactured

from August 1st, 1999 FX2NC-16EYR-T-DS
from October 1st, 2007 FX2NC-16EYR-T

Standard	Remark
IEC1010-1:1990 /A1:1992 BSEN61010-1:1993 * Safety requirements for electrical equipment for measurement, control, and laboratory use - General requirements	The equipment has been assessed as a component for fitting in a suitable enclosure which meets the requirements of IEC1010-1:1990+A1:1992

* Compliance to BSEN61010-1 is claimed through virtue of direct compliance to IEC1010-1 and Amendment 1.

Models : MELSEC FX2N series manufactured

from July 1st, 1997 FX2N-16EYR-ES/UL
from August 1st, 2005 FX2N-8ER-ES/UL FX2N-8EYR-ES/UL
from September 1st, 2010 FX2N-8EYR-S-ES/UL

For the products above, PLCs manufactured before March 31st, 2002 are compliant with IEC1010-1
from April 1st, 2002 to April 30th, 2006 are compliant with EN61131-2:1994+A11:1996+A12:2000
after May 1st, 2006 are compliant with EN61131-2:2007

Standard	Remark
IEC1010-1:1990 /A1:1992 Safety requirements for electrical equipment for measurement, control, and laboratory use - General requirements	The equipment has been assessed as a component for fitting in a suitable enclosure which meets the requirements of IEC1010-1:1990+A1:1992
EN61131-2:1994:2007 /A12:2000 /A11:1996 Programmable controllers - Equipment requirements and tests	The equipment has been assessed as a component for fitting in a suitable enclosure which meets the requirements of EN61131-2:1994+A11:1996+A12:2000, :2007

Caution for compliance with EC Directive**Installation in Enclosure**

Programmable controllers are open-type devices that must be installed and used within conductive control boxes. Please use the FX3GC Series programmable controllers while installed in conductive shielded control boxes. Please secure the control box lid to the control box (for conduction). Installation within a control box greatly affects the safety of the system and aids in shielding noise from the programmable controller.

Caution for Analog Products in use

The analog products have been found to be compliant to the European standards in the aforesaid manual and directive. However, for the very best performance from what are in fact delicate measuring and controlled output device Mitsubishi Electric would like to make the following points;

As analog devices are sensitive by nature, their use should be considered carefully. For users of proprietary cables (integral with sensors or actuators), these users should follow the manufacturers' installation requirements.

Mitsubishi Electric recommends that shielded cables be used. If no other EMC protection is provided, then users may experience temporary loss of accuracy between +10%/-10% in very heavy industrial areas.
However, Mitsubishi Electric suggests that when adequate EMC precautions are followed with general good EMC practice for the users complete control system.

- Sensitive analog cables should not be laid next to or bound with high voltage cabling. Where possible, users should run analog cables separately.
- Good cable shielding should be used. When grounding the shield - ensure that no loops are accidentally created.
- When reading analog values, EMC induced errors can be smoothed out by averaging the readings. This can be achieved either through functions on the analog products or through the user's program in the FX3GC Series PLC main unit.

Associated manuals

FX3GC Series PLC (main unit) comes with this document (hardware manual).

For a detailed explanation of the FX3GC Series hardware and information on instructions for PLC programming and special function block, refer to the relevant documents.

Manual name	Manual No.	Description
FX3GC Series User's Manual - Hardware Edition	JY997D45401 MODEL CODE: 09R533	Explains the FX3GC Series PLC specifications for I/O, wiring, installation, and maintenance.
FX3S/FX3G/FX3GC/FX3U/FX3UC Series Programming Manual - Basic & Applied Instruction Edition	JY997D16601 MODEL CODE: 09R517	Describes PLC programming for basic/applied instructions STL/SFC programming and system devices.
MELSEC-Q/L/F Structured Programming Manual (Fundamentals)	SH-080782 MODEL CODE: 13JW06	Programming methods, specifications, functions, etc. required to create structured programs.
FXCPU Structured Programming Manual [Device & Common]	JY997D26001 MODEL CODE: 09R925	Devices, parameters, etc. provided in structured projects of GX Works2.
FXCPU Structured Programming Manual [Basic & Applied Instruction]	JY997D34701 MODEL CODE: 09R926	Sequence instructions provided in structured projects of GX Works2.
FXCPU Structured Programming Manual [Application Functions]	JY997D34801 MODEL CODE: 09R927	Application functions provided in structured projects of GX Works2.

Manual name	Manual No.	Description
FX Series User's Manual - Data Communication Edition	JY997D16901 MODEL CODE: 09R715	Explains N:N Network, parallel link, computer link, non-protocol communication by RS instructions/FX2N-232IF.
FX3S/FX3G/FX3GC/FX3U/FX3UC Series User's Manual - Analog Control Edition	JY997D16701 MODEL CODE: 09R619	Describes specifications for analog control and programming methods for the FX3S/FX3G/FX3GC/FX3U/FX3UC Series PLC.
FX3S/FX3G/FX3GC/FX3U/FX3UC Series User's Manual - Positioning Control Edition	JY997D16801 MODEL CODE: 09R620	Explains the positioning control specifications of the FX3S/FX3G/FX3GC/FX3U/FX3UC Series and programming procedures.

How to obtain manuals

For the necessary product manuals or documents, consult with the Mitsubishi Electric dealer from where you purchase your product.

Incorporated items

Check if the following product and items are included in the package:

	Included Items	
■ Main units		
	Product	1 unit
FX3GC-32MT/D	FX2NC-100MPCB [1m (3' 3"), three wire]	1 cable
	FX2NC-100BPCB [1m (3' 3"), two wire]	1 cable
	Manuals [Japanese version, English version]	1 manual each
FX3GC-32MT/DSS	Product	1 unit
	FX2NC-100MPCB [1m (3' 3"), three wire]	1 cable
	Manuals [Japanese version, English version]	1 manual each
■ Input / output extension blocks		
	Product	1 unit
FX2NC-□□EX FX2NC-16EX-T	FX2NC-10BPCB1 [0.1m (3.93"), double-ended]	1 cable
	Product	1 unit
FX2NC-□□EX-DS FX2NC-16EX-T-DS FX2NC-□□EYT FX2NC-□□EYT-DSS FX2NC-16EYR-T FX2NC-16EYR-T-DS		1 unit

1. Outline

1.1 Part names

For the input/output extension blocks, refer to the following manual.
→ Refer to FX3GC Series User's Manual - Hardware Edition.

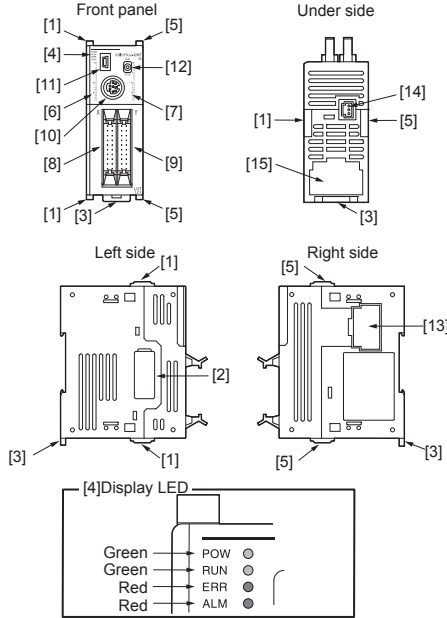

No.	Name
[1]	Special adapter connecting hooks
[2]	Special adapter connector cover
[3]	DIN rail mounting hooks
[4]	Display LED
	POW LED On while power is on the PLC.
	RUN LED On while the PLC is running.
	ERR LED Flashing when a program error occurs.
	ALM LED Lights when a CPU error occurs.
	ALM LED Lights when the battery voltage drops. (When the optional battery is used)
[5]	FX3UC/FX2NC Extension block connecting hooks
[6]	Input LED
[7]	Output LED
[8]	Input connector
[9]	Output connector
[10]	Peripheral device connecting connector (RS-422)
[11]	Peripheral device connecting connector (USB)
[12]	RUN/STOP switch
[13]	FX3UC/FX2NC Extension block connecting connector cover
[14]	Power connector for main unit
[15]	Battery cover

1.2 External dimensions and weight

For the input/output extension blocks, refer to the following manual.

→ Refer to FX3GC Series User's Manual - Hardware Edition.

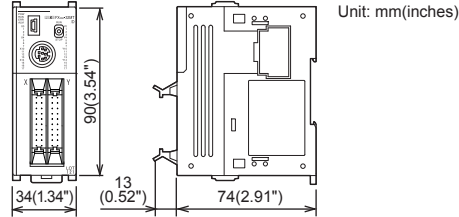

Model name	MASS (Weight): kg (lbs)
FX3GC-32MT/D(SS)	Approx. 0.2 (0.44)

2. Installation (general specifications)

As for installation of the input/output extension blocks and special adapters, refer to the following manual.

→ Refer to FX3GC Series User's Manual - Hardware Edition.

INSTALLATION PRECAUTIONS	WARNING
<ul style="list-style-type: none"> Make sure to cut off all phases of the power supply externally before attempting installation or wiring work. Failure to do so may cause electric shock or damage to the product. 	

INSTALLATION PRECAUTIONS	CAUTION
<ul style="list-style-type: none"> Use the product within the generic environment specifications described in section 2.1 of this manual. Never use the product in areas with excessive dust, oily smoke, conductive dusts, corrosive gas (salt air, Cl₂, H₂S, SO₂ or NO₂), flammable gas, vibration or impacts, or expose it to high temperature, condensation, or rain and wind. If the product is used in such conditions, electric shock, fire, malfunctions, deterioration or damage may occur. Do not touch the conductive parts of the product directly. Doing so may cause device failures or malfunctions. Install the product securely using a DIN rail or mounting screws. Install the product on a flat surface. If the mounting surface is rough, undue force will be applied to the PC board, thereby causing nonconformities. When drilling screw holes or wiring, make sure that cutting and wiring debris do not enter the ventilation slits. Failure to do so may cause fire, equipment failures or malfunctions. Be sure to remove the dust proof sheet from the PLC's ventilation port when installation work is completed. Failure to do so may cause fire, equipment failures or malfunctions. Connect the extension cables, peripheral device cables, input/output cables and battery connecting cable securely to their designated connectors. Loose connections may cause malfunctions. Turn off the power to the PLC before attaching or detaching the following devices. Failure to do so may cause device failures or malfunctions. <ul style="list-style-type: none"> Peripheral devices, extension units/blocks, special adapters, FX Series terminal blocks, extension power supply unit, connector conversion adapter and battery. 	

Notes

- When a dust proof sheet is supplied with an extension block, keep the sheet applied to the ventilation slits during installation and wiring work.
- Do not install the PLC on a floor, a ceiling or a vertical surface. Install it horizontally on a wall as shown in section 2.2.
- Keep a space of 50mm (1.97") or more between the unit main body and another device or structure (part A). Install the unit as far away as possible from high-voltage lines, high-voltage devices and power equipment.

2.1 Generic specifications

Item	Specification			
Ambient temperature	0 to 55°C (32 to 131°F) when operating and -25 to 75°C (-13 to 167°F) when stored			
Ambient humidity	5 to 95%RH (no condensation) when operating			
Vibration resistance ^{*1}	When installed on DIN rail	10 to 57 57 to 150	- 4.9	Half amplitude (mm) 0.035 -
				Sweep Count for X, Y, Z: 10 times (80 min in each direction)
Shock resistance ^{*1}	147m/s ² Acceleration, Action time: 11ms, 3 times by half-sine pulse in each direction X, Y, and Z			
Noise resistance	By noise simulator at noise voltage of 1,000Vp-p, noise width of 1μs, rise time of 1ns and period of 30 to 100Hz			
Dielectric withstand voltage	500V AC for one minute	Between batch of all terminals and ground terminal		
Insulation resistance	5MΩ or higher by 500V DC insulation resistance tester			
Grounding	Class D grounding (grounding resistance: 100Ω or less) <Common grounding with a heavy electrical system is not allowed.> ^{*2}			
Working atmosphere	Free from corrosive or flammable gas and excessive conductive dusts			
Working altitude	<2000m ³			

^{*1} The criterion is shown in IEC61131-2.

^{*2} For common grounding, refer to section 3.2.

^{*3} The PLC cannot be used at a pressure higher than the atmospheric pressure to avoid damage.

2.2 Installation location

Install the PLC in an environment conforming to the generic specifications (section 2.1), installation precautions and notes.

Installation location in enclosure

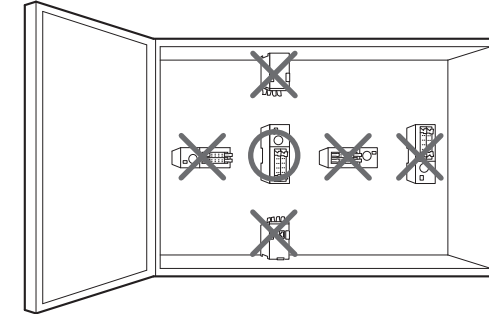

Space in enclosure

Extension devices can be connected on the left and right sides of the main unit of the PLC.

If you intend to add extension devices in the future, keep necessary spaces on the left and right sides.

Configuration without extension cable

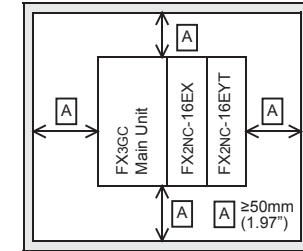

Configuration with extension cable

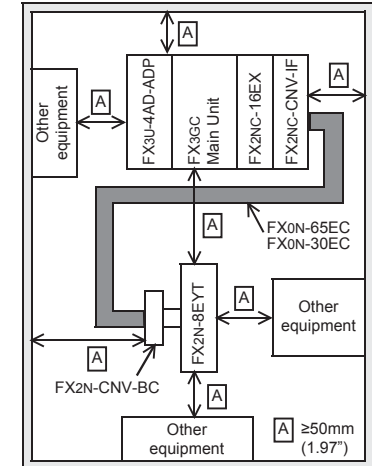

2.3 Procedures for installing to and detaching from DIN rail

The products can be installed on a DIN46277 rail [35 mm (1.38" wide)].

This section explains the installations of the main units.

For the input/output extension blocks and special adapters, refer to the following manual.

→ FX3GC Series User's Manual - Hardware Edition.

2.3.1 Installation

- 1) Turn the power supply OFF.
- 2) Push the DIN rail mounting hooks ① of all connected units/blocks as shown in the figure below ①.

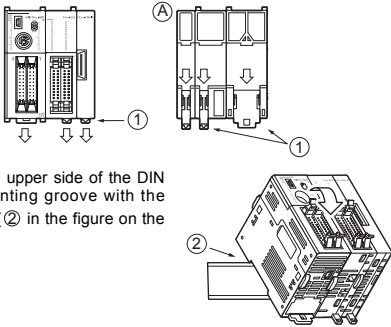

- 3) Align the upper side of the DIN rail mounting groove with the DIN rail (2) in the figure on the right.
- 4) While pressing the main unit onto the DIN rail, lock the DIN rail mounting hooks as shown in the figure below ③.

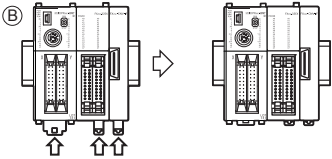

2.3.2 Removal methods

- 1) Turn the power supply OFF.
- 2) Disconnect all connected cables including the power cable and I/O cable.
- 3) Insert a flathead screwdriver to the DIN rail mounting hook (1) in the figure on the right.
- 4) Lever the screwdriver slightly toward direction ②, to pull out the DIN rail mounting hooks, allowing them to come off the DIN rail.
- 5) Remove the main unit from the DIN rail (3) in the figure on the right.
- 6) Push the DIN rail mounting hooks as shown in the figure on the right ④.

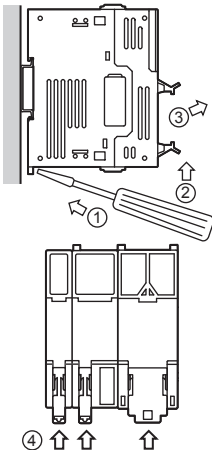

2.4 Connection of power supply connector

Use the dedicated built-in power connector to supply power to the main unit.

The power should be supplied to the main unit, FX2NC Series I/O extension blocks and FX2NC/FX3UC Series special function blocks. Some (FX2NC-□□EX(-T)) of FX2NC Series I/O extension blocks require power cable types "B" and "C" shown on the below, while others (FX2NC-□□EX(-T)-DS) do not require them. For details, refer to FX3GC Series User's Manual - Hardware Edition.

When connecting two or more extension blocks which require power cables "B" and "C" shown on the right, perform crossover wiring between the extension blocks using two (upper and lower) power connectors.

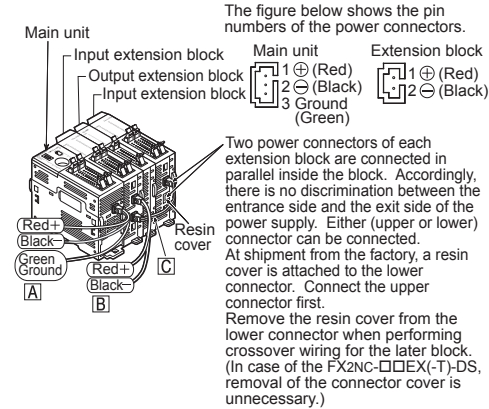

Removal of the power cable

- 1) Turn the power supply OFF.
- 2) Pinch the power cable connector "a" and disconnect it in the direction of the arrow (see figure on the right).

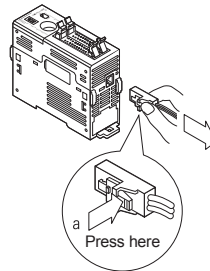

Power Cable types "A" and "B" are supplied with the main unit, while type "C" is supplied with the FX2NC-□□EX and FX2NC-16EX-T.

Type	Application	Model	Length	Cable supplied with
"A"	Power cable for main unit	FX2NC-100MP CB	1m (3' 3")	FX3GC-32MT/D, FX3GC-32MT/DSS
"B"	Input power cable for FX2NC series input extension blocks	FX2NC-100BP CB	1m (3' 3")	FX3GC-32MT/D
"C"	Input power crossover cable for FX2NC series input extension blocks	FX2NC-10BPC B1	0.1m (3.93")	FX2NC-□□EX, FX2NC-16EX-T

The crossover cable (type "C") can skip up to 4 16-point output blocks to connect units.

If more blocks should be skipped to supply power to an input block, use cable type "B".

2.5 Connection to input/output connector

The input/output connectors of the main units conform to MIL-C-83503.

→ Refer to Chapter 4 for the I/O connector pin arrangement.

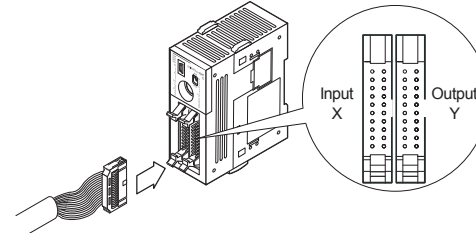

- 1) **Compliant connectors (commercially available connectors)**
Use a 20-pin (1-key) socket connector conforming to MIL-C-83503.
Confirm in advance that the connectors do not interfere with other parts including connector covers.
- 2) **Input/output cables (available from Mitsubishi)**
Input/output cables with attached connectors are available.

Model names	Length	Description	Shape
FX-16E-500CAB-S	5m (16'4")	General-purpose input/output cable	<ul style="list-style-type: none"> • Single wire (Wire color: red) • PLC side: A 20-pin connector
FX-16E-150CAB	1.5m (4'11")	Cables for connecting the FX Series terminal block with input/output connectors. For terminal block connection, refer to FX3GC Series User's Manual - Hardware Edition.	<ul style="list-style-type: none"> • Flat cables (with tube) • A 20-pin connector at both ends
FX-16E-300CAB	3m (9'10")		
FX-16E-500CAB-R	5m (16'4")	Cables for connecting the A Series Model A6TBXY36 connector/terminal block conversion unit and input/output connector type	<ul style="list-style-type: none"> • Round multicore cables • A 20-pin connector at both ends
FX-16E-150CAB-R	1.5m (4'11")		
FX-16E-300CAB-R	3m (9'10")	Cables for connecting the A Series Model A6TBXY36 connector/terminal block conversion unit and input/output connector type	<ul style="list-style-type: none"> • Flat cables (with tube) • PLC side: Two 20-pin connectors in 16-point units. • Terminal block side: A dedicated connector • One common terminal covers 32 input/output terminals.
FX-16E-500CAB-R	5m (16'4")		
FX-A32E-150CAB	1.5m (4'11")	Cables for connecting the A Series Model A6TBXY36 connector/terminal block conversion unit and input/output connector type	<ul style="list-style-type: none"> • Flat cables (with tube) • PLC side: Two 20-pin connectors in 16-point units. • Terminal block side: A dedicated connector • One common terminal covers 32 input/output terminals.
FX-A32E-300CAB	3m (9'10")		
FX-A32E-500CAB	5m (16'4")		

3) Connectors for user-made input/output cables (available from Mitsubishi)

Users should provide electric wires and a pressure bonding tool.

Model name and composition of input/output connector		Applicable electric wire (UL-1061 are recommended) and tool		
Our model name	Details of part (made by DDK Ltd.)	Electric wire size	Pressure bonding tool (made by DDK Ltd.)	
FX2C-I/O-CON for flat cable	10-piece set Solderless connector FRC2-A020-30S	AWG28 (0.1mm ²) 1.27 pitch, 20-core	357J-4674D: Main body 357J-4664N: Attachment	
FX2C-I/O-CON-S for bulk wire	5-piece set Housing HU-200S2-001 Solderless contact HU-411S	AWG22 (0.3mm ²)	357J-5538	
FX2C-I/O-CON-SA for bulk wire	5-piece set Housing HU-200S2-001 Solderless contact HU-411SA	AWG20 (0.5mm ²)	357J-13963	

4) Certified connectors (commercially available connectors)

Connectors made by DDK Ltd. shown in item 3).

2.6 Connection to input/output terminal block

2.6.1 Cable

1) Applicable cable

Type	Wire size
Single wire	0.3mm ² to 0.5mm ² (AWG22 to 20)
Double wire	0.3mm ² (AWG22)×2

2) Termination

Strip the coating of strand wire and twist the cable core before connecting it, or strip the coating of single wire before connecting it. An alternative connection is to use a ferrule with insulating sleeve.

<Reference>

Manufacturer	Model	Caulking tool
Phoenix Contact	AI 0.5-8WH	CRIMPFOX 6 ^{*1} (or CRIMPFOX 6T-F ^{*2})

*1 Old model name: CRIMPFOX ZA 3

*2 Old model name: CRIMPFOX UD 6

- Stranded wire/solid wire
- Bar terminal with insulating sleeve

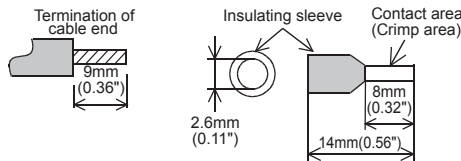

When using a stick terminal with an insulating sleeve, choose a wire with proper cable sheath referring to the above outside dimensions, otherwise the wire cannot be inserted easily.

2.6.2 Tightening Torque

Tighten the terminals to a torque of 0.22 to 0.25 N·m.

Do not tighten terminal screws with a torque outside the above-mentioned range.

Failure to do so may cause equipment failures or malfunctions.

Tool

To tighten terminals, use a purchased small-sized screwdriver whose head is straight and is not widened as shown in the right figure.

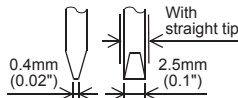

Note:

If the diameter of screwdriver grip is too small, tightening torque will not be able to be achieved. To achieve the appropriate tightening torque shown in the table above, use the following screwdriver or an appropriate replacement (grip diameter approximately 25 mm (0.98 inch)).

<Reference>

Manufacturer	Model
Phoenix Contact	SZS 0.4×2.5

3. Power supply/input/output specifications and examples of external wiring

DESIGN PRECAUTIONS WARNING

- Make sure to have the following safety circuits outside of the PLC to ensure safe system operation even during external power supply problems or PLC failure. Otherwise, malfunctions may cause serious accidents.
 - Most importantly, have the following: an emergency stop circuit, a protection circuit, an interlock circuit for opposite movements (such as normal vs. reverse rotation), and an interlock circuit (to prevent damage to the equipment at the upper and lower positioning limits).
 - Note that when the PLC CPU detects an error, such as a watchdog timer error, during self-diagnosis, all outputs are turned off. Also, when an error that cannot be detected by the PLC CPU occurs in an input/output control block, output control may be disabled. External circuits and mechanisms should be designed to ensure safe machinery operation in such a case.
 - Note that when an error occurs in a relay, triac or transistor output device, the output could be held either on or off. For output signals that may lead to serious accidents, external circuits and mechanisms should be designed to ensure safe machinery operation in such a case.

DESIGN PRECAUTIONS CAUTION

- Do not bundle the control line together with or lay it close to the main circuit or power line. As a guideline, lay the control line at least 100mm (3.94 inch) or more away from the main circuit or power line. Noise may cause malfunctions.
- Install module so that excessive force will not be applied to the built-in programming port, power connectors, I/O connectors, communication connectors, or communication cables. Failure to do so may result in wire damage/breakage or PLC failure.

Notes

- Simultaneously turn on and off the power supplies of the main unit and extension devices.
- Even if the power supply causes an instantaneous power failure for 5 ms or less, the PLC can continue to operate.
- If a long-time power failure or an abnormal voltage drop occurs, the PLC stops, and output is turned off. When the power supply is restored, it will automatically restart (when the RUN input is on).

WIRING PRECAUTIONS WARNING

- Make sure to cut off all phases of the power supply externally before attempting installation or wiring work. Failure to do so may cause electric shock or damage to the product.

WIRING PRECAUTIONS CAUTION

- Connect the DC power supply wiring to the dedicated terminals described in this manual. If an AC power supply is connected to a DC input/output terminal or DC power supply terminal, the PLC will burn out.
- Do not wire vacant terminals externally. Doing so may damage the product.
- Perform class D grounding (grounding resistance: 100Ω or less) to the grounding terminal on the main unit. Do not use common grounding with heavy electrical systems (refer to section 3.2).
- When drilling screw holes or wiring, make sure cutting or wire debris does not enter the ventilation slits. Failure to do so may cause fire, equipment failures or malfunctions.
- Make sure to properly wire to the terminal block (European type) in accordance with the following precautions. Failure to do so may cause electric shock, equipment failures, a short-circuit, wire breakage, malfunctions, or damage to the product.
 - The disposal size of the cable end should follow the dimensions described in the manual.
 - Tightening torque should follow the specifications in the manual.
 - Twist the end of strand wire and make sure that there are no loose wires.
 - Do not solder-plate the electric wire ends.
 - Do not connect more than the specified number of wires or electric wires of unspecified size.
 - Affix the electric wires so that neither the terminal block nor the connected parts are directly stressed.

Notes

- Input/output wiring 50 to 100m (164'1" to 328'1") long will cause almost no problems of noise, but, generally, the wiring length should be less than 20m (65'7") to ensure the safety.
- Extension cables are easily affected by noise. Lay the cables at a distance of at least 30 to 50mm (1.19" to 1.97") away from the PLC output and other power lines.

3.1 Power supply specifications and example of external wiring

→ For more details, refer to FX3GC Series User's Manual - Hardware Edition.

3.1.1 Power supply specifications

The specifications for the power supply of the main unit are shown in the following table.

Item	Specification
Supply voltage	24V DC +20% -15%
Allowable instantaneous power failure time	Operation can be continued upon occurrence of an instantaneous power failure for 5ms or less.
Power fuse	125V 3.15A
Rush current	30A max. 0.5ms/24V DC
Power consumption ^{*1}	8W
5V DC built-in power supply ^{*2}	400mA

*1 Input/output extension blocks and special function blocks are not contained in power consumption. For power consumption of the FX2NC input/output extension blocks, refer to the following table.

Model names	Power consumption
FX2NC-16EX-T(-DS)	2.2W
FX2NC-16EX(-DS)	2.2W
FX2NC-32EX(-DS)	4.2W
FX2NC-16EYR-T(-DS)	2.2W
FX2NC-16EYT(-DSS)	0.35W
FX2NC-32EYT(-DSS)	0.7W

→ Refer to the FX3GC Series User's Manual - Hardware Edition.
→ For the power consumed by the special function blocks, refer to the appropriate manuals.

*2 Cannot be used to supply power to an external destination. This power is supplied to input/output extension blocks, special function blocks and special adapters only.

3.1.2 Example of external wiring (power type)

Supply 24V DC power to the main unit and FX2NC-□□EX(-T) using the dedicated connector.

→ For the details of wiring work, refer to Section 2.4

→ For the power supply wiring of the FX2NC input extension blocks, refer to the Subsection 3.3.3

Use a 24V DC +20% -15% DC power supply. The allowable range of the 24V DC power supply may be narrower when special function blocks are connected.

→ For more details, refer to the FX3GC Series User's Manual - Hardware Edition

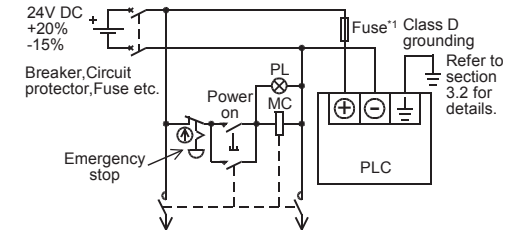

Power supply for loads connected to PLC output terminals

*1 A UL Listed or Recognized fuse rated not higher than 3.47A must be used with FX3GC.

3.2 Grounding

Ground the PLC as stated below.

- Perform class D grounding. (Grounding resistance: 100 Ω or less)
- Ground the PLC independently if possible. If it cannot be grounded independently, ground it jointly as shown below.

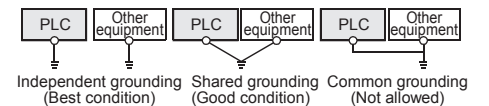

- Position the grounding point as close to the PLC as possible to decrease the length of the ground wire.

3.4.2 Handling of transistor output circuit

Output terminal:

The main unit and FX2NC input/output extension block have 16 transistor output points per common.

Two COM* or +V△ terminals connected to each other inside the PLC are provided for outputs.

Connect two COM* or +V△ terminals outside the PLC so that the load applied to each COM* or +V△ terminal is smaller.

Where * indicates:1 to 3

Where △ indicates:0 to 2

Output current:

The ON voltage of the output transistor is approx. 1.5V. When driving a semiconductor element, carefully check the input voltage characteristics of the applied element.

3.4.3 External Wiring of Transistor Output

1. External wiring of sink output type

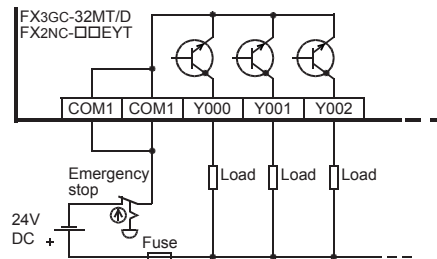

2. External wiring of source output type

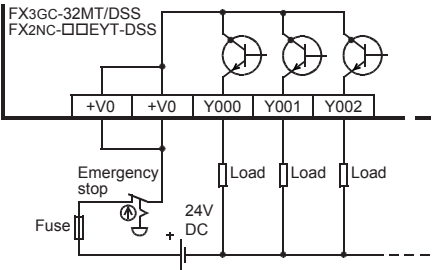

3.5 Relay output specifications and example of external wiring

→ For more details, refer to FX3GC Series User's Manual - Hardware Edition.

3.5.1 Relay output specifications

Item	Specification (Relay)	
Number of output points	FX2NC-16EYR-T(-DS)	16 points
Output connecting type	Terminal block	
External power supply	30V DC or less or 240V AC or less (250V AC or less when the unit does not comply with CE, UL or cUL standards)	
Max. load	Resistance load	2A /point When using one COM□ terminal, make sure that the total load current of 8 resistance load points is 4 A or less. When connecting two COM□ terminals outside the PLC, make sure that the total load current of 8 resistance load points is 8A or less.
	Inductive load	80VA → For the product life of relay contacts, refer to the FX3GC Series User's Manual - Hardware Edition.
Min. load	5V DC, 2mA (reference value)	
Open circuit leakage current	-	
Response time	OFF→ON	10ms or less
	ON→OFF	10ms or less
Circuit insulation	Mechanical insulation	
Display of output operation	LED lights when power is applied to relay coil.	

3.5.2 Handling of relay output circuit

Output terminal:

Main units, FX2NC input/output extension blocks have 8 relay output points per common.

Two COM* terminals connected to each other inside the FX2NC-16EYR-T(-DS) are provided for outputs.

Connect two COM* terminals outside the PLC so that the load applied to each COM* terminal is smaller.

Where * indicates:1 or 2

3.5.3 Example of relay output wiring

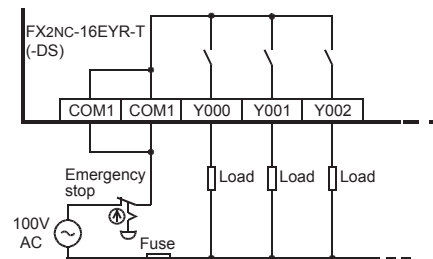

3.6 Cautions in input and output wiring

→ For more details, refer to FX3GC Series User's Manual - Hardware Edition.

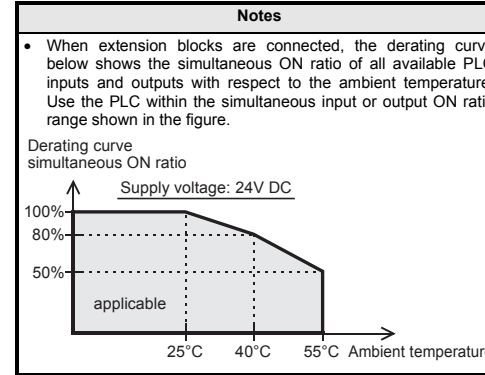

3.6.1 Instructions for connecting input devices

- In the case of no-voltage contact
The input current of this PLC is 5 to 7mA/24V DC. Use input devices applicable to this minute current. If no-voltage contacts (switches) for large current are used, contact failure may occur.
- In the case of input device with built-in series diode
The voltage drop of the series diode should be approx. 4V or less. When lead switches with a series LED are used, up to two switches can be connected in series. Also make sure that the input current is over the input-sensing level while the switches are ON.
- In the case of input device with built-in parallel resistance
Use a device with a parallel resistance of 15kΩ or more. When the resistance is less than 15kΩ, connect a bleeder resistance.
- In the case of 2-wire proximity switch
Use a two-wire proximity switch whose leakage current is 1.5mA or less when the switch is off. When the current is larger than 1.5mA, connect a bleeder resistance.

3.6.2 Cautions on transistor output wiring

- Protection circuit for load short-circuits
A short-circuit at a load connected to an output terminal could cause burnout at the output element or the PCB. To prevent this, a protection fuse should be inserted at the output. Use a load power supply capacity that is at least 2 times larger than the total rated fuse capacity.
- Contact protection circuit for inductive loads
When an inductive load is connected, connect a diode (for commutation) in parallel with the load as necessary. The diode (for commutation) must comply with the following specifications.

Reverse voltage	5 to 10 times of the load voltage
Forward current	Load current or more
- Interlock
Loads, such as contactors for normal and reverse rotations, that must not be turned on simultaneously should have an interlock in the PLC program and an external interlock.

3.6.3 Cautions on relay output wiring

- Protection circuit for load short-circuiting
When a load connected to the output terminal short-circuits, the printed circuit board may be burnt out. Fit a protective fuse on the output circuit.
- Protection circuit of contact when inductive load is used
An internal protection circuit for the relays is not provided for the relay output circuit in this product. It is recommended to use inductive loads with built-in protection circuits. When using loads without built-in protection circuits, insert an external contact protection circuit, etc. to reduce noise and extend the product life.
 - DC circuit
Connect a diode in parallel with the load. Use a diode (for commutation) having the following specifications.

Reverse voltage	5 to 10 times the load voltage
Forward current	Load current or more
 - AC circuit
Connect the surge absorber (combined CR components such as a surge killer and spark killer, etc.) parallel to the load. Select the rated voltage of the surge absorber suitable to the output used. Refer to the table below for other specifications.

Electrostatic capacity	Approx. 0.1μF
Resistance value	Approx. 100 to 200Ω
- Interlock
Loads, such as contactors for normal and reverse rotations, that must not be turned on simultaneously should have an interlock in the PLC program and an external interlock.
- Common mode
Use output contacts of the PLC in the common mode.

4. Terminal layouts

4.1 Main units

4.1.1 FX3gc-32MT/D

The I/O wiring is different in the FX3gc-32MT/DSS. Refer to Sections 3.3 and 3.4 for the details.

FX3gc-32MT/D

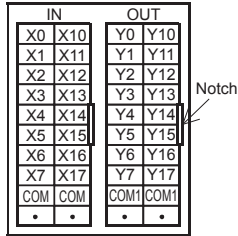

4.1.2 FX3gc-32MT/DSS

The I/O wiring is different in the FX3gc-32MT/D. Refer to Sections 3.3 and 3.4 for the details.

FX3gc-32MT/DSS

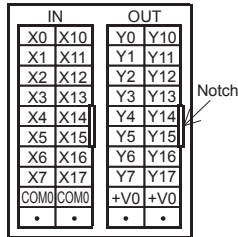

4.2 FX2nc input/output extension blocks

4.2.1 FX2nc-□□EX(-DS)

FX2nc-16EX

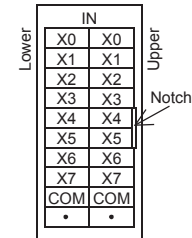

FX2nc-32EX

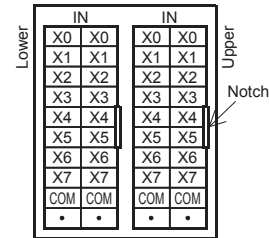

FX2nc-16EX-DS

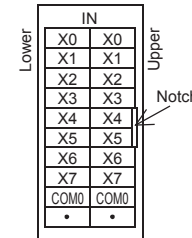

FX2nc-32EX-DS

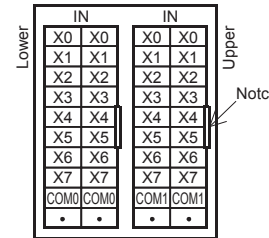

4.2.2 FX2nc-□□EYT(-DSS)

FX2nc-16EYT

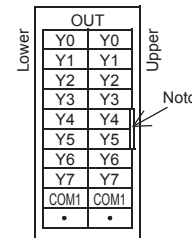

FX2nc-32EYT

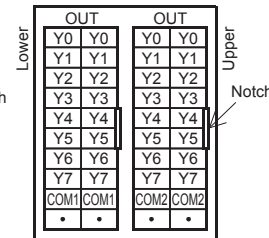

FX2nc-16EYT-DSS

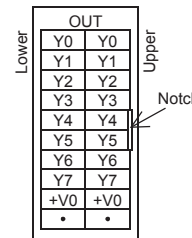

FX2nc-32EYT-DSS

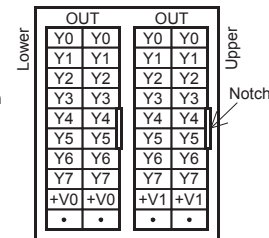

4.2.3 FX2nc-16EX-T(-DS), FX2nc-16EYR-T(-DS)

FX2nc-16EX-T(-DS)

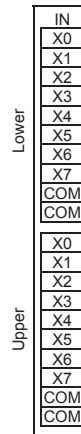

FX2nc-16EYR-T(-DS)

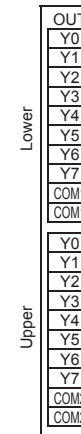

5. 「电器电子产品有害物质限制使用标识要求」的表示方式



Note: This symbol mark is for China only.

含有有害6物质的名称, 含有量, 含有部品
本产品中所含有的有害6物质的名称, 含有量, 含有部品如下表所示。

部件名称	有害物质					
	铅 (Pb)	汞 (Hg)	镉 (Cd)	六价铬 (Cr (VI))	多溴联苯 (PBB)	多溴二苯醚 (PBDE)
可编程控制器	○	○	○	○	○	○
印刷基板	×	○	○	○	○	○

本表格依据SJ/T 11364的规定编制。

○:表示该有害物质在该部件所有均质材料中的含量均在GB/T 26572规定的限量要求以下。
×:表示该有害物质至少在该部件的某一均质材料中的含量超出GB/T 26572规定的限量要求。

This manual confers no industrial property rights or any rights of any other kind, nor does it confer any patent licenses. Mitsubishi Electric Corporation cannot be held responsible for any problems involving industrial property rights which may occur as a result of using the contents noted in this manual.

Warranty
Exclusion of loss in opportunity and secondary loss from warranty liability
Regardless of the gratis warranty term, Mitsubishi shall not be liable for compensation to:
(1) Damages caused by any cause found not to be the responsibility of Mitsubishi.
(2) Loss in opportunity, lost profits incurred to the user by Failures of Mitsubishi products.
(3) Special damages and secondary damages whether foreseeable or not, compensation for accidents, and compensation for damages to products other than Mitsubishi products.
(4) Replacement by the user, maintenance of on-site equipment, start-up test run and other tasks.

For safe use

- This product has been manufactured as a general-purpose part for general industries, and has not been designed or manufactured to be incorporated in a device or system used in purposes related to human life.
- Before using the product for special purposes such as nuclear power, electric power, aerospace, medicine or passenger movement vehicles, consult with Mitsubishi Electric.
- This product has been manufactured under strict quality control. However when installing the product where major accidents or losses could occur if the product fails, install appropriate backup or failsafe functions in the system.