

CURTAIN INSTALLATION

Guide

GRAHAM & BROWN
EST. 1946

WAVE TRACK - OUTSIDE MOUNT

Parts Identified

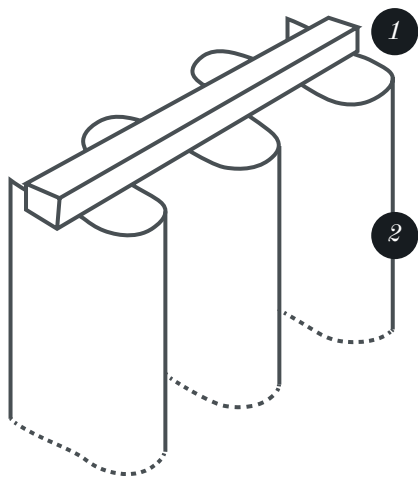

1 Wave Curtain Track

2 Wave Curtain

Additional Parts

 Screws*

 Brackets

Tools Required

 Pencil

 Drill

 Screwdriver

 Tape Measure

For outside the mount fitting it is recommended to use a **FACE FIXING**.

Installation Guide

1. CURTAIN HEIGHT

Hold one curtain up to the window to establish the top and bottom position of the curtain. Use a pencil to mark the top of the curtain on the wall. Place curtain neatly to one side.

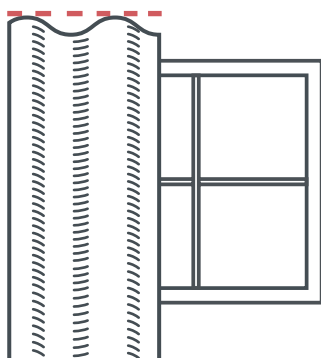

2. MARK THE TRACK POSITION

Position the track against the wall so the hole in the carrier is level with the marks in Step 1. Mark the top of the track and use a spirit level to mark a straight line across your wall. You will fit your brackets along this line.

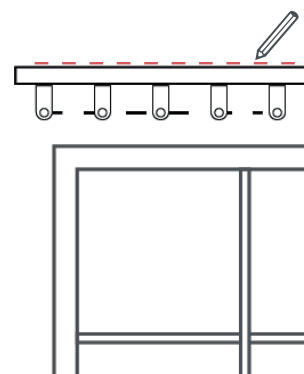

3. MEASURE

The brackets need to be positioned 2" in from each side of the curtain track. Using your tape measure, mark these points with a pencil. Evenly space additional brackets between the two end brackets.

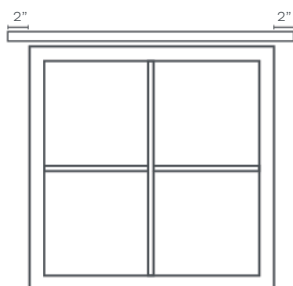

4. FIX BRACKETS

It is recommended to fit your brackets into your wall via a face fixing. Hold the brackets up to the pencil marks made in Step 3. Mark the relevant hole with a pencil. Drill holes and use suitable screws to fix the brackets. With a spirit level, check the brackets are level.

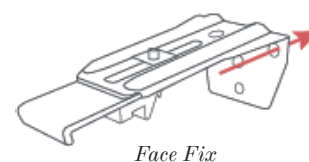

5. FITTING THE TRACK

Unscrew the gold screw underneath the bracket slightly to allow the cantilever to slide back and forth.

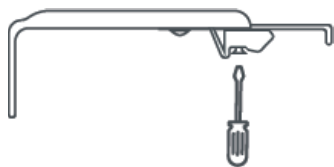

6. FITTING THE TRACK

There is no front or back to the track so it can be fitted either way. Angle the track into the bracket and push into the cantilever. The track should snap into position. Tighten the gold screw underneath the bracket to hold the track in place.

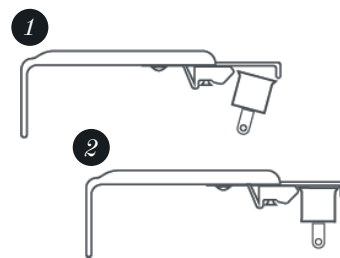

7. FITTING THE CURTAIN

Make sure the runners are spread out along the track. Starting from the outermost hook. Slide the hooks that are attached to the curtain tape into the runners.

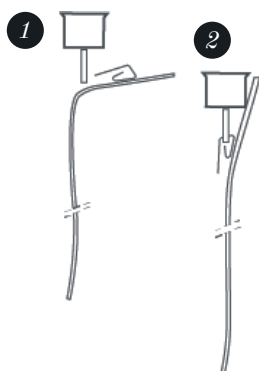

Dressing Your Curtains

Use a steamer or the steam setting on your iron to gently steam out any creases in the fabric. Be careful not to touch the fabric whilst doing this. We recommend tying back your curtains for 48 hours to help get a better form.

Cleaning Instructions

Dry clean only.

*Before you start fitting your curtain track make sure the screws are suitable for the surface you are fitting into. Some surfaces will require wall plugs and different screws to the ones we provide.

GRAHAM & BROWN
EST. 1946

grahambrown.com

CURTAIN INSTALLATION

Guide

GRAHAM & BROWN
EST. 1946

WAVE TRACK - INSIDE MOUNT

Parts Identified

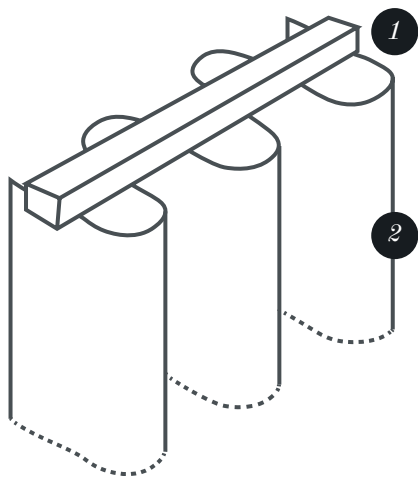

1 Wave Curtain Track

2 Wave Curtain

Additional Parts

 Screws*

 Brackets

Tools Required

 Pencil

 Screwdriver

 Drill

 Tape Measure

For inside the mount fitting it is recommended to use a TOP FIXING.

Installation Guide

1. MEASURE

The brackets need to be positioned 2" in from each side of your recess. Using your tape measure, mark these points with a pencil. Evenly space additional brackets between the two end brackets.

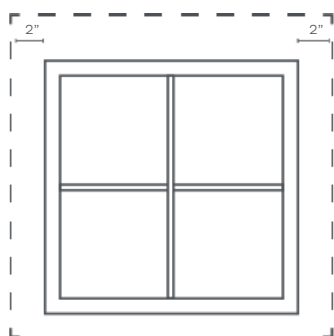

2. FIX BRACKETS

To fit inside the recess, you will need to top fix the brackets. Hold the bracket to the marks made in Step 1 and mark the relevant hole with a pencil. Drill the holes and use suitable screws to hold the brackets in place.

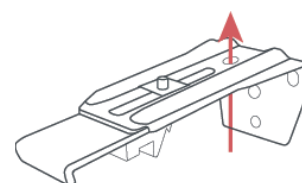

Top Fix

3. FITTING THE TRACK

Unscrew the gold screw underneath the bracket slightly to allow the cantilever to slide back and forth.

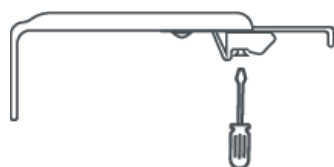

4. FITTING THE TRACK

There is no front or back to the track so it can be fitted either way. Angle the track into the bracket and push into the cantilever. The track should snap into position. Tighten the gold screw underneath the bracket to hold the track in place.

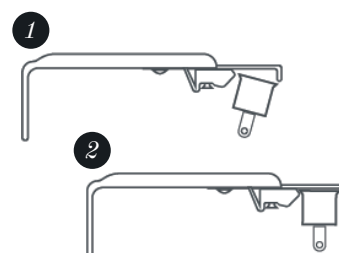

5. FITTING THE CURTAIN

Make sure the runners are spread out along the track. Starting from the outermost hook. Slide the hooks that are attached to the curtain tape into the runners.

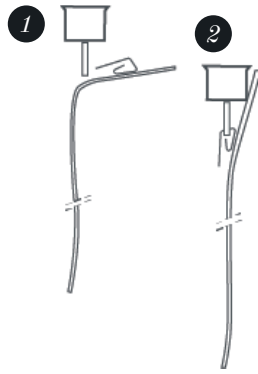

Dressing Your Curtains

Use a steamer or the steam setting on your iron to gently steam out any creases in the fabric. Be careful not to touch the fabric whilst doing this. We recommend tying back your curtains for 48 hours to help get a better form.

Cleaning Instructions

Dry clean only.

*Before you start fitting your curtain track make sure the screws are suitable for the surface you are fitting into. Some surfaces will require wall plugs and different screws to the ones we provide.

GRAHAM & BROWN
EST. 1946

grahambrown.com